

# Charlton & Jenrick

*Best of British fires, fireplaces & stoves*

## **ELECTRIC FIREPLACE INSERT** INSTRUCTION MANUAL

**MODEL NO.:A-0993**

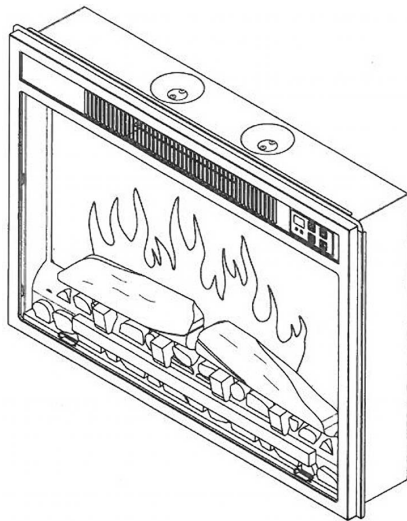

PLEASE READ THE INSTRUCTIONS CAREFULLY BEFORE INSTALLING AND  
USING APPLIANCE.

SAVE THIS INSTRUCTION MANUAL FOR FUTURE REFERENCE.

## CONTENTS

1. Important Safety Information.....	1
2. Technical Specifications.....	3
3. Parts And Hardware.....	4
4. Appliance Dimensions.....	5
5. Installation Instructions.....	5
6. Operating Instructions.....	6
7. Maintenance.....	12
8. Others.....	13

## 1. IMPORTANT SAFETY INFORMATION

- **Read all of the instructions carefully before using the appliance.**
- **For indoor use only.** This appliance is not suitable for use outside the house and **only suitable for well insulated spaces or occasional use.**
- Do not use this appliance in the immediate surroundings of a bath, a shower or a swimming pool.
- Do not use this fire as a free-standing appliance. It must always be fixed to the wall, fireplace mantel, floor etc.
- This fire must not be located immediately below or in front of a socket-outlet.
- This appliance must be earthed.
- This appliance must not be supplied through an external switching device, such as a timer, or connected to the circuit that is regularly switched on and off by utility in order to avoid a hazard due to the inadvertent resetting of the thermal cut out.
- If the power cord is damaged, it must be repaired by the manufacturer, its authorized service center or professional person in order to avoid a hazard.
-  The figure in the marking is **“Do Not Cover”**. **Warning:** in order to avoid overheating, do not allow the appliance to be covered or let the air inlet/outlet become obstructed. Please note the warning on the appliance.
- To reduce the risk of fire, keep textiles, curtains, or any other flammable material a minimum distance of 1 meter from the air outlet.
- Keep the power cords away from hot surfaces and hot conditions. Do not route the power lead in front of the appliance.
- Do not use this fire in rooms that have explosive gas in them (for example petrol), or if you are using solvents, glue, aerosol spray or in flammable paints, as these may catch fire.

- This appliance is not intended for use by persons (including children) with reduced physical, sensory or mental capabilities, or lack of experience and knowledge, unless they have been given supervision or instruction concerning use of the appliance by a person responsible for their safety.
- Cleaning and user maintenance shall not be made by children without supervision.
- Some parts of this product can become very hot and cause burns. Particular attention has to be given where children and vulnerable people are present.
- Do not use this appliance in small rooms when they are occupied by persons not capable of leaving the room on their own, unless constant supervision is provided.
- Children should be supervised to ensure that they do not play with the appliance.
- Keep the power plug accessible after installation for the purpose of isolation.
- Children of less than 3 years should be kept away unless continuously supervised or a fireguard is fitted .
- Children aged from 3 years and less than 8 years shall only switch on/off the appliance provided that it has been placed or installed in its intended normal operating position and they have been given supervision or instruction concerning use of the appliance in a safe way and understand the hazards involved. Children aged from 3 years and less than 8 years shall not plug in, regulate and clean the appliance or perform user maintenance.

### **WARNING! Information below for authorized person or service centre only:**

A non-rewireable plug fitted with a 13A fuse is supplied . Should the fuse or plug need replacing, and you are competent to do so, it must be replaced with a 13A fuse or plug being 13A BS1363A approved.

## 2. TECHNICAL SPECIFICATIONS

### MODEL NO.: A-0993

Supply Voltage: AC 230-240V 50Hz

Maximum power consumption: 2KW/h

Power for flame effect: 4.8W/h

### HEAT OUTPUT:

Nominal heat output (Pnom): 2KW

Minimum heat output (indicative) (Pmin): 1.8KW

Maximum continuous heat output (Pmax): 2KW

### AUXILIARY ELECTRICITY CONSUMPTION:

At nominal heat output (elmax): 15.5W/h

At minimum heat output (elmin): 15.5W/h

In standby mode (elSB): 1.2W/h

#### TYPE OF HEAT OUTPUT/ROOM TEMPERATURE CONTROL

Single stage heat output and no room temperature control	NO
Two or more manual stages, no room temperature control	NO
With mechanical thermostat room temperature control	NO
With electronic room temperature control	YES
Electronic room temperature control plus day timer	YES
Electronic room temperature control plus week timer	YES

#### OTHER CONTROL OPTIONS

Room temperature control, with presence detection	NO
Room temperature control, with open window detection	YES
With distance control option	NO
With adaptive start control	YES
With working time limitation	NO
With black bulb sensor	NO

Control PCB	Remote Control Receiver	Remote Control Transmitter
Hardware: RC01-075A Software: RC01-075A01	Hardware: YH-M88-7	Maximum transmit current: 20mA Software: RCS31A01

## 3. PARTS AND HARDWARE

- Unpack the fire carefully, make sure that the appliance is intact with no signs of damage caused by transport and that no parts have been exposed to water. If in doubt, do not use the appliance and contact an authorized service center.
- Keep plastic wrapping away from children.
- Save the original packaging as this may be required in the event of service complaint with product.
- Check that all parts are removed from the packaging.

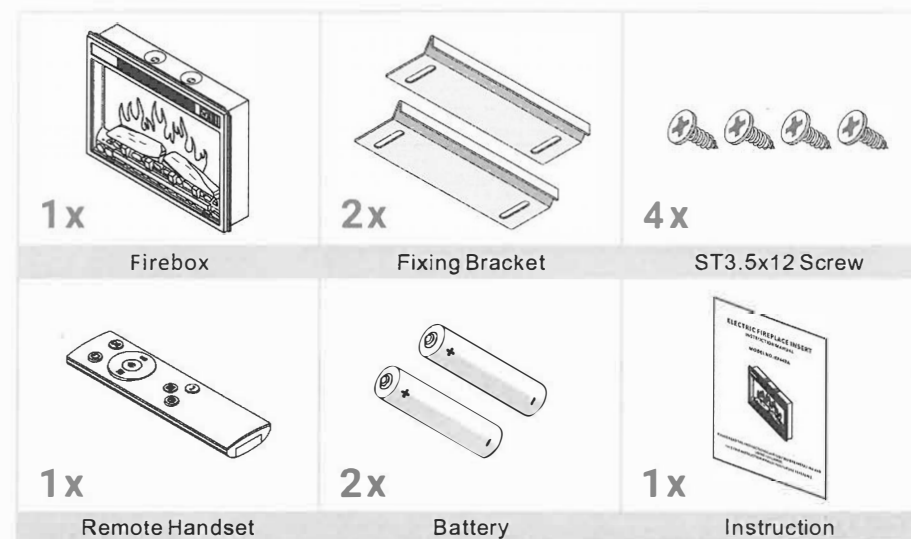

## 4. APPLIANCE DIMENSIONS

Unit:mm

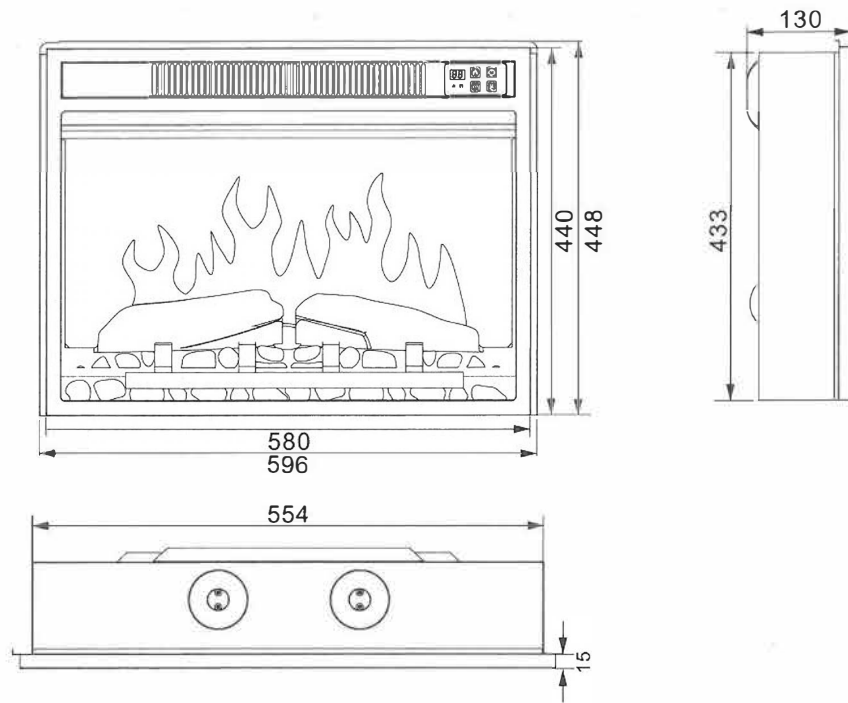

## 5. INSTALLATION INSTRUCTIONS

### 1. PREPARATION BEFORE INSTALLATION

#### TOOLS REQUIRED

A screwdriver, a spirit level and drill will be needed.

#### SETTING UP THE APPLIANCE

Your new electric fireplace may be installed virtually anywhere in your home. However, when choosing a location, ensure that the general instructions are followed.

- For best results, install out of direct sunlight.
- The appliance should be connected to an earthed electrical outlet and it must be easily accessible to allow disconnection.

## 2. INSTALL THE APPLIANCE

- Install the appliance from the back of the mantel.
- Use 4 pcs ST3.5x12 screws to fix the fixing brackets on both sides of the mantel.

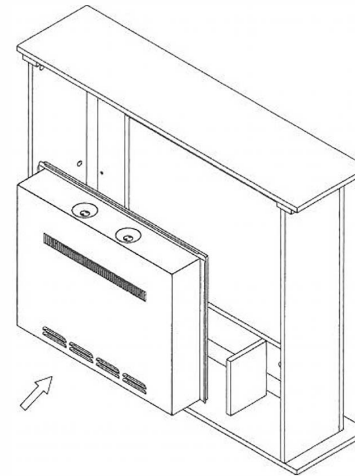

*Backside of the mantel*

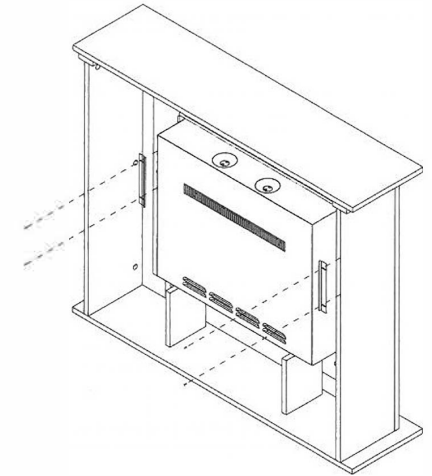

*Use 4pcs ST3.5x12 screws*

## 6. OPERATING INSTRUCTIONS

### 1. GENERAL

**WARNING!** Do not operate the appliance if it is damaged or has malfunctioned. If you suspect the appliance is damaged or has malfunctioned, call a qualified service engineer to inspect the appliance, and replace any part of the electrical system if necessary, before re-use.

**WARNING!** To reduce the risk of fire, keep textiles, curtains, or any other flammable material a minimum distance of 1 meter from the air outlet.

- MAKE SURE the plug fits tight in the outlet. Faulty wall outlet connections or loose plugs can cause the outlet to overheat.
- DO NOT disconnect the power at the mains supply whilst the appliance is running. Use the remote control handset and the manual button on appliance to turn the fire off before disconnecting.

The appliance can be operated conveniently in 2 different ways: manually or via the remote control handset.

## 2. MANUAL CONTROL PANEL

### NOTE:

- The manual buttons control basic functions, not a full range of controls. Use the remote handset to carry out all functions.

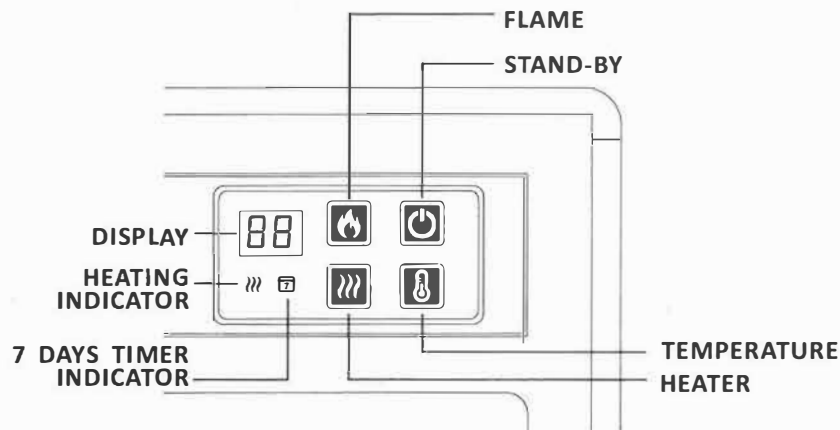



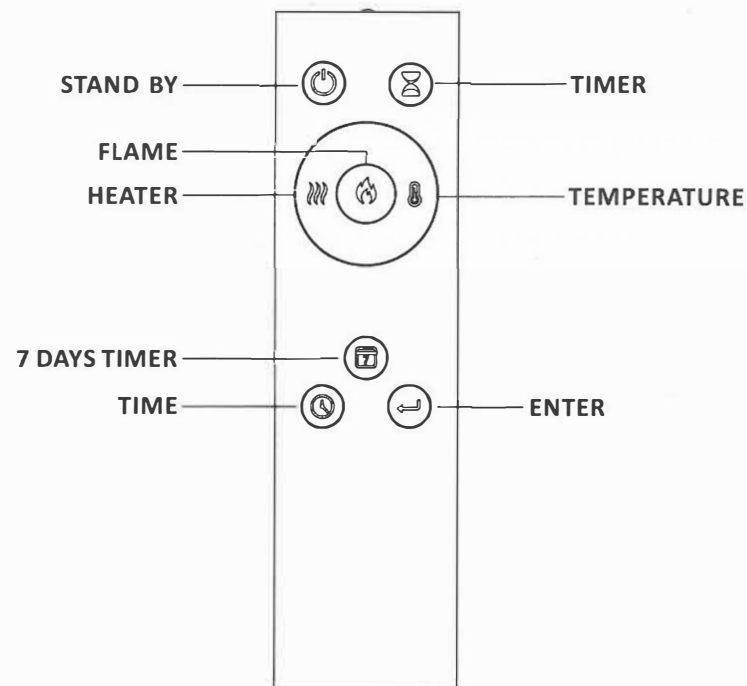

1. **STAND BY**: Press to turn on or turn off the flame effects and heater.
2. **FLAME**: Repeatedly press to cycle through 3 flame effects.
3. **HEATER**: Press to turn on/off the heater.
4. **TEMPERATURE**: Repeatedly press to select the temperature you want the room to reach from the range of 16-28°C (60-82°F) and then 58°C (99°F), which will keep the heater on. Hold the button to switch between °C/°F.







## 3. REMOTE CONTROL











Icon	Title	Function	Fireplace Response
	<b>STANDY BY</b>	Press to turn on or turn off the flame effects and heater.	The flame runs. The current flame setting shows on the display.
	<b>FLAME</b>	Repeatedly press to cycle through 3 flame effects.	The flame runs. L1, L2, L3 shows on the display.

	<b>TIMER</b>	Repeatedly press to cycle through timer options. Select an amount of time for the appliance to operate, and then automatically turn off. Choose between 0.5, 1, 2, 3, 4, 5, 6, 7, 8, 9 hours.	The number 30, 1H, 2H, 3H, 4H, 5H, 6H, 7H, 8H, 9H, 0H will show on the display.
	<b>HEATING</b>	Press to turn on/off the heater. The heater can be run independently.	The temperature shows on the display and the heater indicator will turn off after 10 seconds if the flame effect is on
	<b>TEMPERATURE</b>	Press to select the temperature you want the room to reach from the range of 16-28°C (60-82°F) and then 58°C (99°F), which will keep the heater on. Hold the button to switch the unit between °C/°F	The display of the appliance shows the temperature.  16-28 in Celsius degree corresponds to 60-82 in Fahrenheit degree. There will be changes in number while switching between °C/°F.
	<b>TIME</b>	Press to set the heating start and end time.	The number shows on the display.
	<b>7 DAYS TIMER</b>	Press to turn on or off the 7 days timer for heater.	7 days timer and heater indicators are both on.

### Set Up Current Day and Time

Hold time button  on the remote to enter date and time setting mode; Repeatedly press time button  to select date, D1-D7 will show on the display which represents Monday-Sunday. Press button  to confirm, and then automatically enter hour setting. Press button  to set the hour, and press button  to save and then automatically enter minute setting. Press button  again to set minute and then press  to save.

### Set Up the 7 Days Timer

- Hold the button  on the remote until the 7 days timer indicator on the firebox flashes to enter 7 days timer setting mode.
- D1 (Monday) will show on the display and then press  to confirm; then 00 will show on the display. Press button  to set the time for turning on the heater and then press  to confirm; The 00 will show on the display, press  to set the time for turning off the heater and then press  to confirm. **PLEASE NOTE: There is only one period each day for heating on and off.**
- Repeat the steps above to set the timer for D2 to D7 (Tuesday to Sunday). The display on fire will show the time for turning on and off the heater as same as the time of last day. If you want to change the time, press the button .
- If you don't want to set for a certain day, just set both start and end time as 00.
- Hold 7 days timer button  to save all settings after you finish the setting for Sunday. The indicator will stop to flash.
- The weekly timer will be set only when you finish the setting from Monday to Sunday completely. During the setting process, the pause of more than 20 seconds will terminate the entire weekly timer setting.

### OPEN WINDOW DETECTION

Open Window Detection is an innovative eco feature that detects a rapid drop in room temperature caused by an open window. The warning word "oP" will be displayed on the appliance and the heater will be turned off. If the room temperature rises or the remote control is operated manually, the heater will return to its normal working state.

### Adaptive Start Control

Learning from the previous heating cycle enables the appliance to judge the appropriate advance time to turn on the heater to ensure that the set temperature is reached at the set time. For example, if your timer is set to start at 18:00 and temperature is set to 23°C, the fire may for example come on at 17:30 to ensure the room is 23°C at 18:00.

## IMPORTANT SAFETY INFORMATION FOR REMOTE CONTROL

1. Two AAA alkaline batteries are required for the remote control;
2. Use the thumb press and push the bar figure on the back cover down simultaneously, then take out the cover and remove the battery or insert the battery, after this put the cover back to its body back;
3. This AAA alkaline battery (non-recharged) is not to be recharged;
4. Different types of batteries or new and used batteries are not to be mixed;
5. Batteries are to be inserted with the correct polarity;
6. Exhausted batteries are to be removed from the appliance and safely disposed of;
7. If the remote control is to be stored unused for a long period, the batteries should be removed;
8. The supply terminals are not to be short-circuited

## RESETTING THE THERMAL CUT OUT

The appliance is fitted with an Electronic Safety Control (E.S.). This is a safety device which switches off the fire if, for any reason, the appliance overheats, e.g. when covered. If the heater stops operating while the flame effect continues working normally, this indicates that the E.S. Control is in operation. The E.S. control can only be re-set after the appliance has cooled down, and the appliance has been reset. Resetting of the E.S. Control procedures are as follows :

1. Press button **STAND BY** on fire to turn off the appliance and leave it off for approximately 10-15 minutes.
2. Remove any obstruction to the fan heater outlet or fan blades etc. Make sure that the power supply is disconnected with the plug socket outlet while doing this.
3. Turn on the appliance and the E.S. Control will be reset.
4. Ensure that the appliance is functioning correctly. If the E.S. Control operates again. The appliance should be checked by a competent electrician.

## 7. MAINTENANCE

**WARNING!** Before any maintenance or cleaning of the exterior of the fireplace, the unit should be disconnected from the power supply until it has cooled.

### REMOTE HANDSET BATTERY REPLACEMENT

Replace with two AAA batteries. Make sure the batteries are installed correctly in the remote control.

### MAINTENANCE OF MOTORS

The motors used on the fan and flame effect are pre-lubricated for extended bearing life and require no further lubrication. However, periodic cleaning/vacuuming of the fan/heater unit is recommended.

### CLEANING THE FIREPLACE

You can clean the exterior of the fireplace with a soft, damp, lint-free cloth. DO NOT use cleaning or polishing products. To remove fingerprints or other marks on the front glass panel, use a soft, damp, lint-free cloth with a good quality household glass cleaner. The front glass panel should always be completely dried with a clean, lint-free cloth or paper towel.

**WARNING!** Abrasive cleaners should not be used on the glass panel. Liquids should not be sprayed directly onto any surface of the unit.



### Environment



Meaning of crossed –out wheeled dustbin:

Electrical appliances should not be disposed as unsorted municipal waste. Separate collection facilities should be used in the disposal of electrical appliances. Contact your local government for the information about the available collection systems. If electrical appliances are disposed of in landfills or dumps, hazardous substances can leak into the groundwater and get into the food chain, damaging your health and well-being. When old appliances are replaced by the new ones, it is a legal oblige for the retailer to take back the old appliance for disposals at least free of charge.



This fire complies with the Safety Standards EN60335-1 and EN 60335-2-30 which covers the essential requirements of the Low Voltage Directive 2014/35/EU and the EMC standards EN55014-1; EN55014-2; EN61000-3-2 and EN61000-3-3 which covers the essential requirements of the European Electro Magnetic Compatibility 2014/30/EU



This fire complies with the Safety Standards BS EN60335-1 and BS EN60335-2-30 which covers the essential requirements of the Electrical Equipment (Safety) Regulations 2016 (S.I.2016/1101) and the EMC standards BS EN55014-1; BS EN55014-2; BS EN61000-3-2 and BS61000-3-3 which covers the essential requirements of the Electromagnetic Compatibility Regulations 2016 (S.I.2016/1091).

### **Katell Limited**

478-480 Durham Way North,  
Aycliffe Industrial Park,  
Newton Aycliffe DL5 6HP, UK

Email: [sales@katell.co.uk](mailto:sales@katell.co.uk)

Tel: 01325 379060; 01325 309120<sup>3</sup>